



MEETING TABLE

TRAINING TABLE

QUICK COLLABORATION

MEETING CHAIR

# S A I B I

# Coloring the communication space into a comfortable and high-quality space

SAIBI was born out of a commitment to all qualities, such as the unique form of the material, advanced functionality, sound, touch, operability, and consideration to the invisible places. Create a comfortable and high-quality communication space colored with functional beauty.

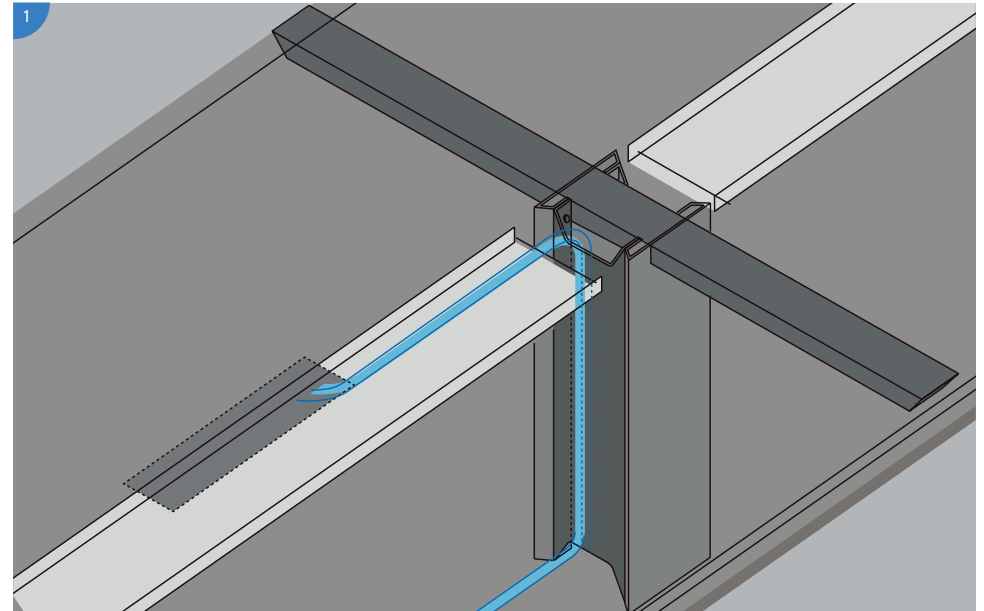
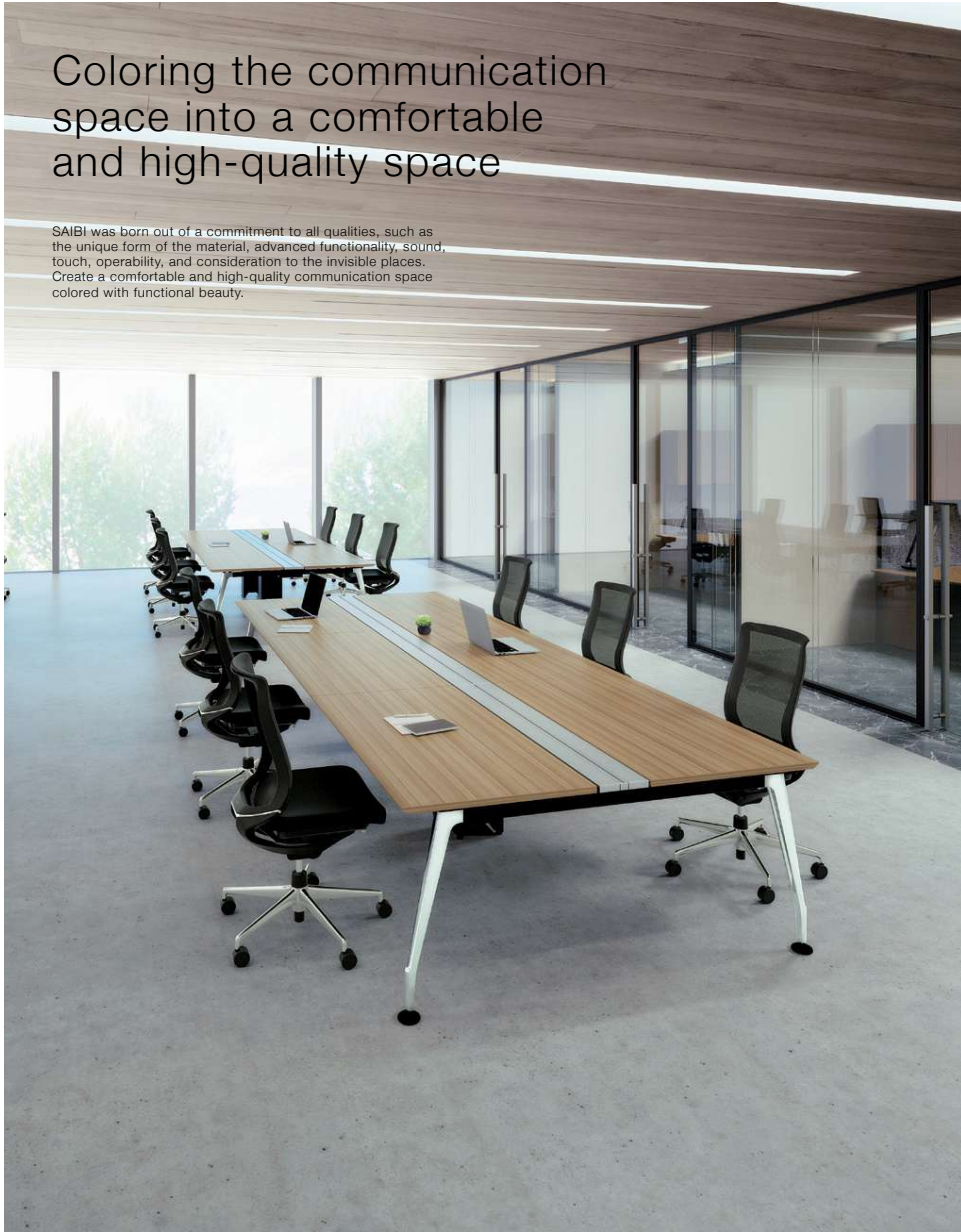

## Details

1

### Intermediate leg wiring

The top plate split type allows large-capacity wiring to set up from the middle.

2

### Wiring in single pole base

The circle type can be wired from a position slightly away from the center of the top plate, and can be set up within a single pillar base.

3

### Telephone stand <SA series>

A telephone stand that achieves an advanced design with an elegant texture.

# Material Selections



## Table Top Colour Options

PAW White	MC1 Grained Natural	MH3 Grained Medium (Vertical Pattern)
MT4 Grained Light Brown	MD8 Grained Dark Brown	

\*The wood grain top plate is a random pattern, therefore the specification will not match.

## Leg Colour Options

<b>Polished Legs</b>	<b>Coated Legs</b>
PM	S81 Flat Silver

# Furniture Options

## Wiring Cover

### Wood Wiring Cover Type



### Aluminium Wiring Cover Type



# Type Variations and Dimensions

## Circle Type : Melamine



φ 900 H 720



φ 900 H 1000

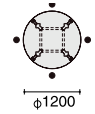

φ 1200 H 720



## Type Variations and Dimensions

Square Type : Melamine



H 720 W 1800

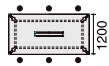

H 720 W 2400

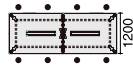

H 720 W 3200

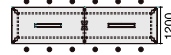

H 720 W 4800

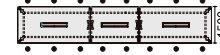

H 720 W 6400

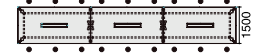

H 720 W 7200